

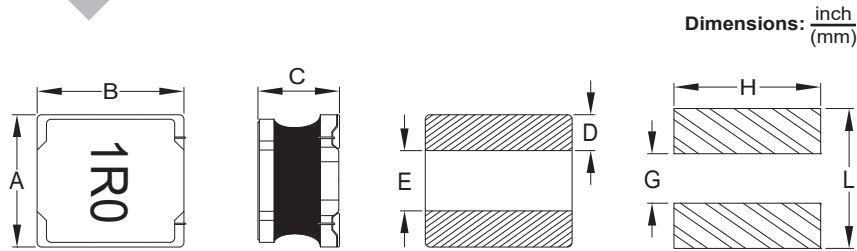

SMD SEMI SHIELDED POWER CHIP INDUCTOR

PCHP42NF



Dimensions: $\frac{\text{inch}}{\text{(mm)}}$

Recommended PCB Layout

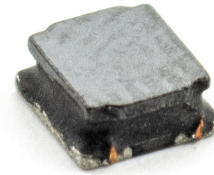

A	B	C	D	E	G	H	L
.157±.008 (4.0±0.2)	.157±.008 (4.0±0.2)	.071 Max (1.8)	.059 Ref (1.2)	.063 Ref (1.6)	.055 (1.4)	.165 (4.2)	.165 (4.2)

Allied Part Number	Inductance (μH)	Tolerance (%)	Test Freq. (KHz) @ 1.0V	DCR (Ω) ±20%	Isat (A) Typ	Isat (A) Max	Irms (A) TYP	Irms (A) MAX
PCHP42NF-1R0N-RC	1.0	30	100	.027	4.00	3.60	3.70	3.60
PCHP42NF-1R5N-RC	1.5	30	100	.032	3.30	3.00	3.30	3.00
PCHP42NF-2R2M-RC	2.2	20	100	.042	3.00	2.70	2.90	2.70
PCHP42NF-3R3M-RC	3.3	20	100	.055	2.30	2.20	2.30	2.20
PCHP42NF-4R7M-RC	4.7	20	100	.070	2.00	1.90	2.00	1.90
PCHP42NF-6R8M-RC	6.8	20	100	.098	1.70	1.60	1.70	1.60
PCHP42NF-100M-RC	10	20	100	.150	1.50	1.40	1.50	1.40
PCHP42NF-150M-RC	15	20	100	.190	1.10	1.00	1.10	1.00
PCHP42NF-220M-RC	22	20	100	.290	0.90	0.80	0.90	0.80
PCHP42NF-330M-RC	33	20	100	.405	0.75	0.70	0.75	0.70
PCHP42NF-470M-RC	47	20	100	0.55	0.60	0.55	0.60	0.55
PCHP42NF-680M-RC	68	20	100	0.89	0.55	0.50	0.55	0.50
PCHP42NF-101M-RC	100	20	100	1.38	0.45	0.40	0.45	0.40
PCHP42NF-151M-RC	150	20	100	1.97	0.35	0.30	0.35	0.30
PCHP42NF-221M-RC	220	20	100	3.00	0.30	0.25	0.30	0.25

All specifications subject to change without notice.

Features

- Semi Magnetically Shielded
- High Current
- Low DC Resistance

Electrical

Inductance Range: 1.0μH to 220μH
Tolerance: ±20% over entire range, ±30% for 1.0μH and 1.5μH values
Operating Temp: -40°C to +125°C
Isat: Current at which the Inductance will drop by no more than 30% of its initial value.
Irms: Based on a temp rise of ΔT = 40°C typical above Ambient Temperature.

Solder Ability

Pre-Heat: 150°C, 60 sec.
Solder Composition: Sn 96.5% / Ag3% / Cu0.5%
Temperature: 245±5°C
Flux for Lead Free: Rosin 9.5%
Dip Time: 4±1 sec.
Depth: completely cover terminals

Test Equipment

(L): HP4284A, CH11025, CH3302, CH1320, CH1320S LCR Meter
(DCR): CH16502, Agilent 33420A Micro-Ohm Meter

Physical

Packaging: 3500 per 13" Tape and reel
Marking: EIA Code

Reflow Soldering

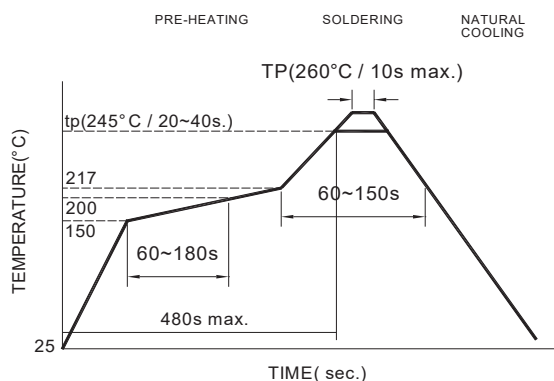



Typical Performance Curves

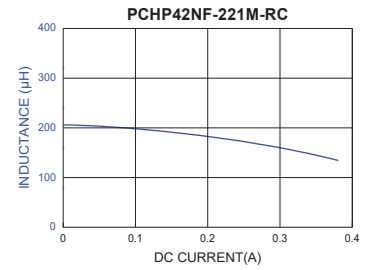
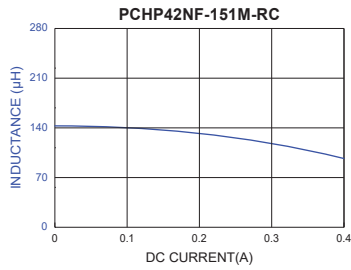
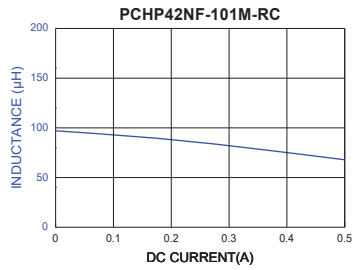
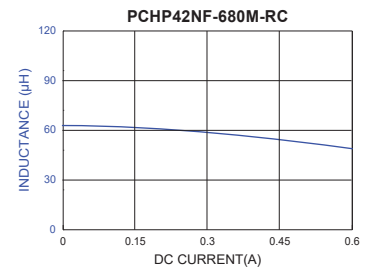
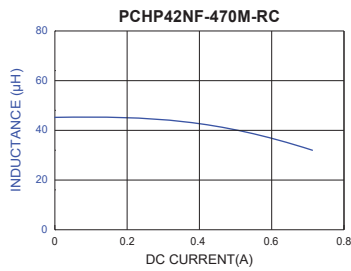
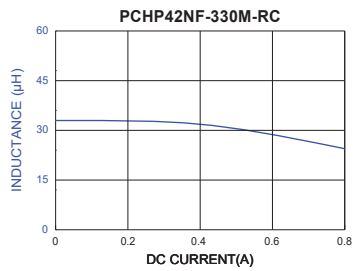
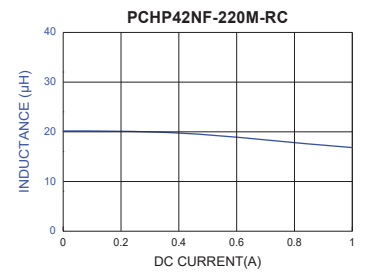
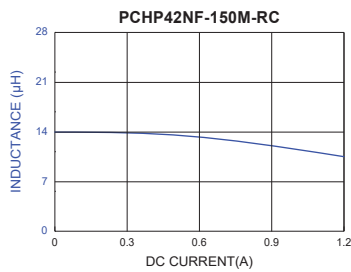
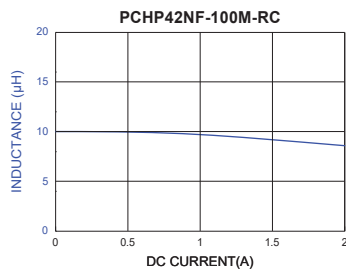
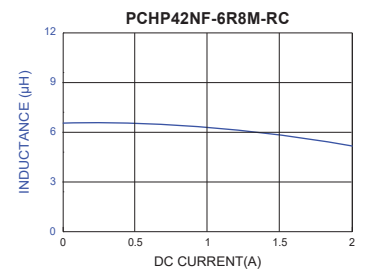
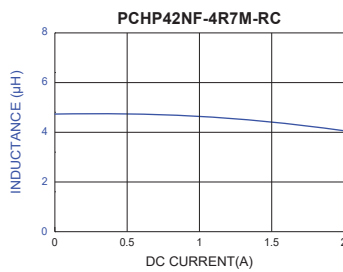
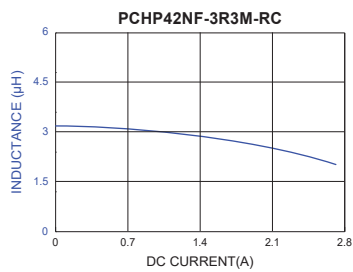
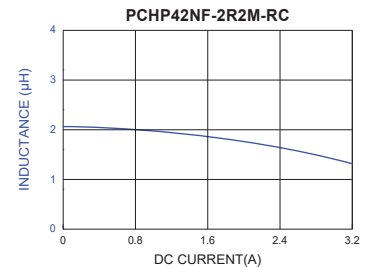
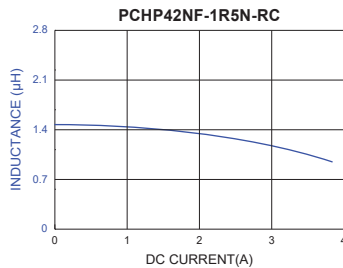
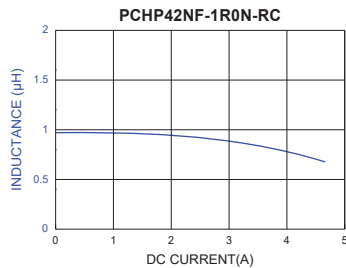



Packaging Information

Dimensions: mm

Reel Dimension

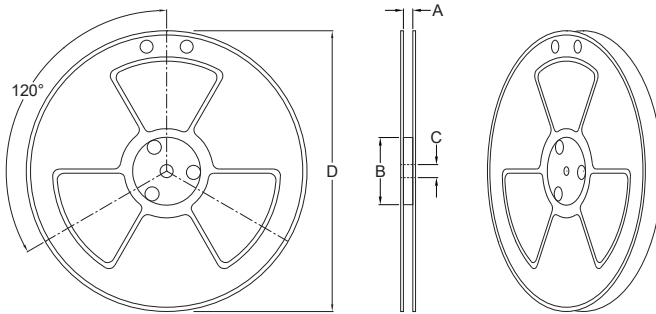

Type	A(mm)	B(mm)	C(mm)	D(mm)
330x12mm	12.0±1.5	100±0.5	13.2±0.5	330±0.5

Tape Dimension

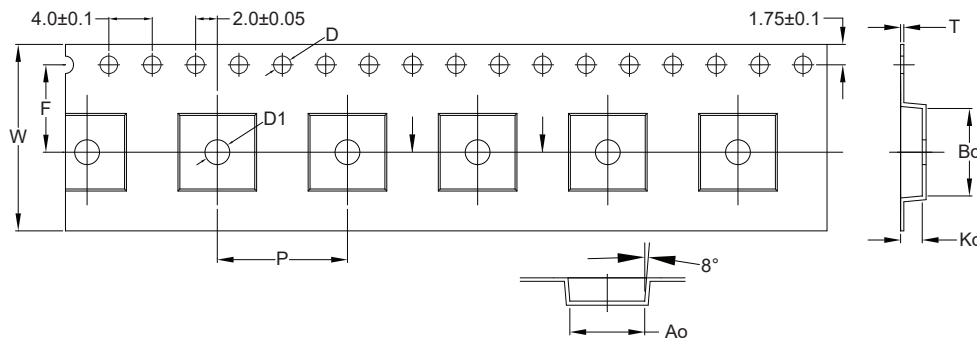

Bo(mm)	Ao(mm)	Ko(mm)	P(mm)	W(mm)	F(mm)	t(mm)	D(mm)	D1(mm)
4.35±0.1	4.50±0.1	1.90±0.1	8.0±0.1	12.0±0.3	5.5±0.1	0.25±0.05	1.5+0.1/-0.0	1.5±0.1

Tearing Off Force

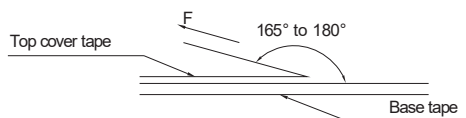

The force for tearing off cover tape is 15 to 80 grams in the arrow direction under the following conditions.

Room Temp. (°C)	Room Humidity (%)	Room atm (hPa)	Tearing Speed mm/min
5~35	45~85	860~1060	300

Application Notice

• Storage Conditions

- To maintain the solderability of terminal electrodes:
- 1. PCHP42NF Series meets IPC/JEDEC J-STD-020D standard-MSL, level 1.
- 2. Temperature and humidity conditions: Less than 40°C and 60% RH.
- 3. Recommended products should be used within 12 months form the time of delivery.
- 4. The packaging material should be kept where no chlorine or sulfur exists in the air.

• Transportation

- 1. Products should be handled with care to avoid damage or contamination from perspiration and skin oils.
- 2. The use of tweezers or vacuum pick up is strongly recommended for individual components.
- 3. Bulk handling should ensure that abrasion and mechanical shock are minimized.