



Single Port RJ45 CONNECTOR WITH INTEGRATED MAGNETICS, TAB DOWN

- 10/100/1000 Base-T Ethernet Application
- Meets IEEE 802.3 & ANSI X 3.263 standards
- Impedance: 100OHMS
- Transmit open circuit inductance (OCL): 350uH (MIN) @100KHz,0.1VRMS with 8mA DC Bias
- Always EU RoHS/ELV Compliant, wave solder capable to 265°C
- RJ45 jack cavity conforms to FCC rules and regulations Part 68, SUB Part F
- Standard operating temp: 0°C to +70°C
- Storage temperature range: -25°C to +125°C

Electrical Specifications @ 25°C

Part Number	OCL(uH Min) @ 100kHz, 0.1V With 8mA DC Bias	Turns Ratio chip: cable (±3%)	Insertion Loss (dB Max)	Return Loss (dB Min)	
	0.5-100MHz		0.5-40MHz	40.1-100MHz	
ARA502-1122S	350	1CT:1CT	1.1	18	12-20*log(f/80)

Electrical Specifications @ 25°C

Part Number	EMI Fingers	LED (L/R)	Cross Talk (dB Min)		CMRR (dB Min) 0.5-100MHz	HI-POT (VDC)
			0.5-40MHz	40.1-100MHz		
ARA502-1122S	NO	G/Y	35	33-20*log(f/50)	30	2250

All specifications subject to change without notice.

MECHANICAL

Unless otherwise specified all tolerances are: ±0.25 in mm

ARA502-1122S

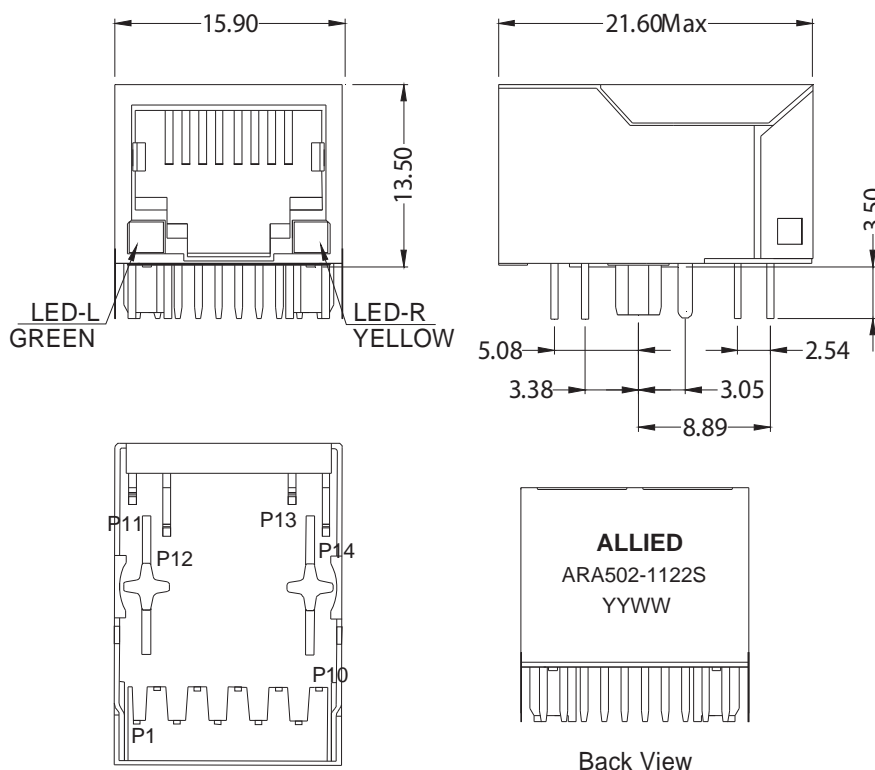

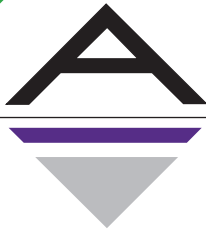

Single Port RJ45 CONNECTOR WITH INTEGRATED MAGNETICS, TAB DOWN

SCHEMATICS

ARA502-1122S

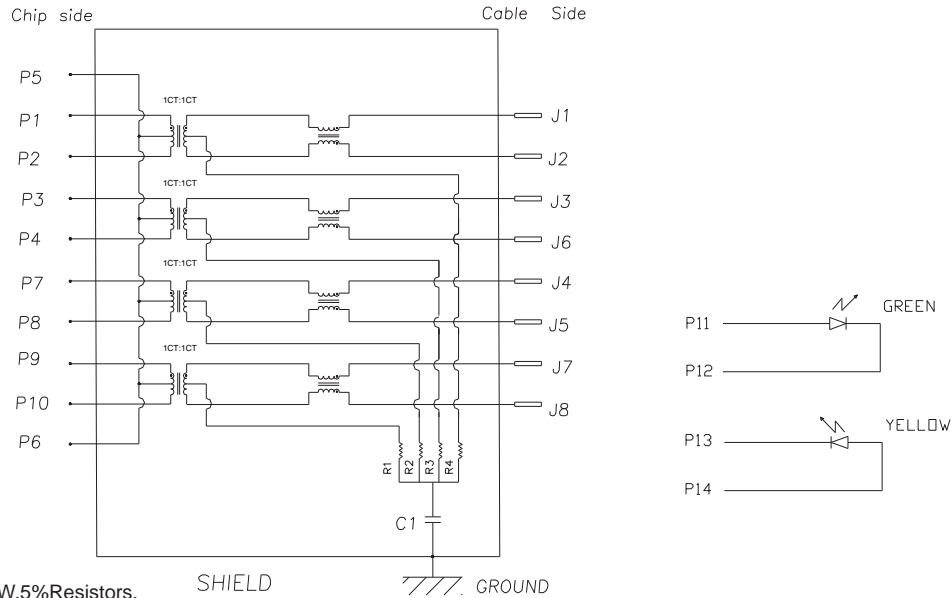

Notes:

1. R1-R4=75OHMS,1/16W,5%Resistors.
2. C1=1000pF,2KV Decoupling Capacitor.
3. LED Compliant With IEC60825-1 Safety of Laser Products When operated Up to 20mA.
4. LED Forward Voltage: 2.1V(TYP), LED Power Dissipation: 105mW, LED Peak Wavelength: Green=565nm, Yellow=585nm.

PCB LAYOUT

ARA502-1122S

Unless otherwise specified all tolerances are: ± 0.05 in mm

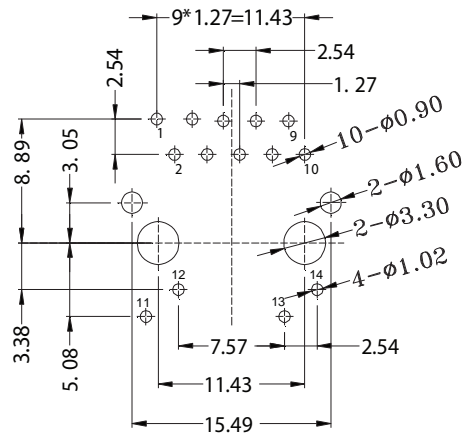

MATERIALS

ARA502-1122S

- Housing: PBT, Flammability Rating 94V-O.
- Shell: C2680 Brass, 0.20mm thick, 50u" Min nickel plating.
- Mod Jack Contacts: Phosphor Bronze, 0.35mm thick, 6u" Gold plated.
- LED: Diffused Epoxy Lens, 0.5x0.5mm Carbon Steel wireframe leads.